



TOOL
CATALOGUE
2008



**DISTRIBUTORS OF QUALITY
DRYWALL TOOLS AND ACCESSORIES**

ALL ORDERS PLACED BY 11AM EST WILL BE SHIPPED SAME DAY

Telephone: 905-669-6336
Toll Free Tel: 1-800-590-5799

Fax: 905-669-9092
Toll Free Fax: 1-800-833-5487

WWW.WALLBOARDTRIM.COM • INFO@WALLBOARDTRIM.COM

Quick-Find Product Guide

TAPING KNIVES AND TROWELS	1-2
MIXERS, SANDERS, TAPE HOLDERS AND EXTENSION POLES	3
TEXTURE BRUSHES, SCRAPERS AND ACCESS PANELS	4
TEXTURE SPRAY TOOLS AND ACCESSORIES	5
DUST MASKS	6
HOMAX SPRAY TEXTURE PRODUCTS	6
SANDPAPER . . . ROLLS, BLOCKS, SCREENS AND SPONGES	7
MESH TAPE, MESH TAPER AND SURE CORNER ROLL-ON BEAD	8
TAPING TOOLS, FLUSHERS, TUBES AND APPLICATORS	9
DRYWALL LIFTERS, SAWS, KNIVES AND CRIMPERS	10
AVIATION SNIPS	11
MEASURING TAPES, CHALK REEL AND CHALK LINE	11
T-SQUARES, RASPS AND CLINCHERS	11
PREMIER INTERNATIONAL AUTOMATIC TAPING TOOLS	12-13
HAMMERS AND HATCHETS	14
LEATHER POUCHES AND BELTS	15-16
STAPLES AND STAPLE GUNS	16
PREST-ON DRYWALL CLIPS	17
ROTOZIP ROUTER AND BITS	17
BENCHES, EXTENDABLE PLANKS AND LADDERS	18-19
SCAFFOLDS AND ACCESSORIES	19-21
DRYWALL DOLLIES AND CASTERS	22
ALUMINUM AND MAGNESIUM STILTS	23
DRYWALL PANEL LIFTERS	24

DuraGrip Putty Knife with Hammer Head

Fully hardened high carbon steel blade, precision ground with mirror finish. Full tang construction, comfortable rubber handle.



Carbon Steel Blade

- CB3084** 4" flex joint knife 12/ctn.
- CB3085** 5" flex joint knife 12/ctn.
- CB3086** 6" flex joint knife 12/ctn.

Soft Grip Plaster Trowel

Comfortable rubber handle.

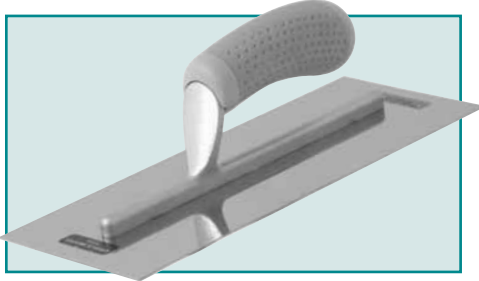

Carbon Steel Blade

- CB16200** 4 1/2" x 11 1/2" 12/ctn.

Stainless Steel Blade

- CB16210** 4 1/2" x 11" 12/ctn.
- CB16211** 4 1/2" x 11 1/2" 12/ctn.
- CB16212** 4 1/2" x 12" 12/ctn.
- CB16214** 4 1/2" x 16" 12/ctn.

Drywall Corner Trowel

Flexible, tempered stainless steel blade for finishing inside and outside corners.

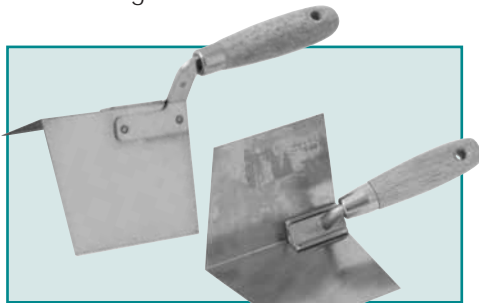

- CB16185** 2 1/2" x 4" 103° inside corner 10/ctn.
- CB16186** 2 1/2" x 4" 80° outside corner 10/ctn.

Nylon Handle with Hammer Head

Fully hardened high carbon steel blade, precision ground with mirror finish. Heat treated. Full tang construction. Lacquer coated. Brass rivet. Solid metal hammer end.



Carbon Steel Blade

- CB3073** 3" flex putty knife 12/ctn.
- CB3074** 4" flex joint knife 12/ctn.
- CB3075** 5" flex joint knife 12/ctn.
- CB3076** 6" flex joint knife 12/ctn.

Stainless Steel Blade

- CB3094** 4" flex joint knife 12/ctn.
- CB3095** 5" flex joint knife 12/ctn.
- CB3096** 6" flex joint knife 12/ctn.

Plaster Trowel

Flexible, tempered and polished spring steel blade. Aluminum alloy shank and blade are mounted and fastened with 9 rivets. Smoothly turned wooden handle.

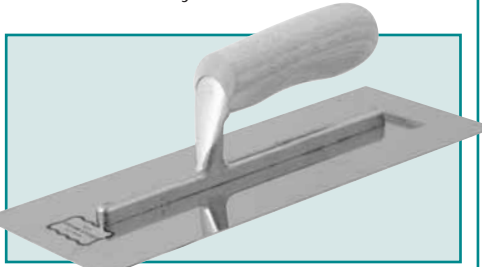

Stainless Steel Blade

- CB16190** 4 1/2" x 11" 12/ctn.
- CB16191** 4 1/2" x 11 1/2" 12/ctn.
- CB16192** 4 1/2" x 14" 12/ctn.

Carbon Steel Blade

- CB16260** 4 1/2" x 11" 12/ctn.
- CB16261** 4" x 12" 12/ctn.
- CB16262** 4" x 14" 12/ctn.
- CB16263** 4" x 16" 12/ctn.

True Fit Corner Trowel

Creates clean sharp corners. 3 1/2" blade, 5" plastic handle, 90° to 135°.

CB010



Paint Shield

Aluminum mounting holds a flexible 24" plastic blade.

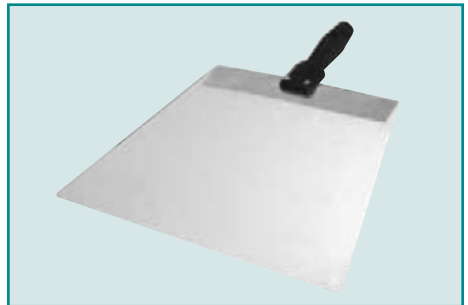

- WT88009** 24" paint shield 6/ctn.

Knock-Down Knife

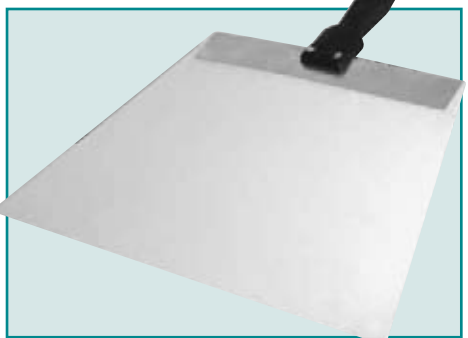

- CB14083** 18" x 12" Lexan
- CB14084** 24" x 12" Lexan

Plaster Hawk



- CB16270** 13" x 13" aluminum hawk 6/ctn.
- CB16272** 13 1/2" x 13 1/2" aluminum hawk 6/ctn.
- CB16271** 10" x 10" aluminum hawk 6/ctn.

Curved Blade Drywall Trowel

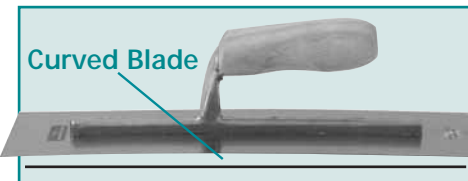

- CB16265** 4 1/2" x 12" 12 / ctn.
- CB16266** 4 1/2" x 14" 12 / ctn.

Swimming Pool Trowel

Stainless steel blade, tempered and shaped, with smooth wooden handle.

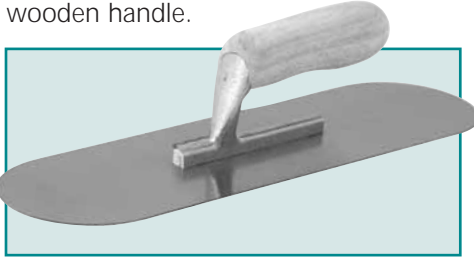

CB16180 4" x 14" 6/ctn.

Plastic Smoothing Trowel

Durable all plastic construction with an easy grip handle. Ideal for smoothing exterior stucco.

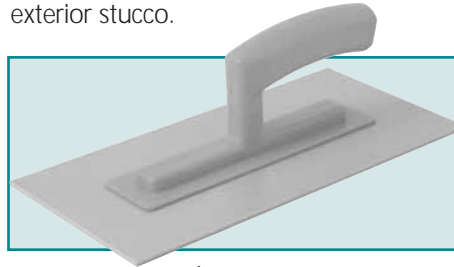

CB16181 5 1/2" x 11" 10/ctn.

Taping Knife

Flexible, tempered steel blade with strong steel back.

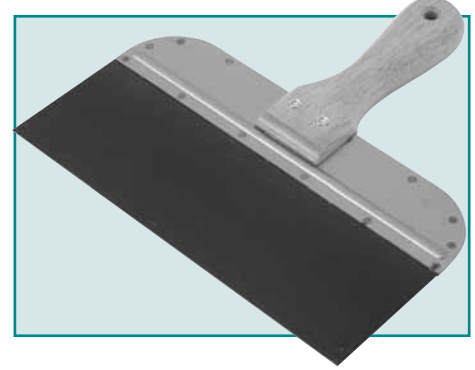
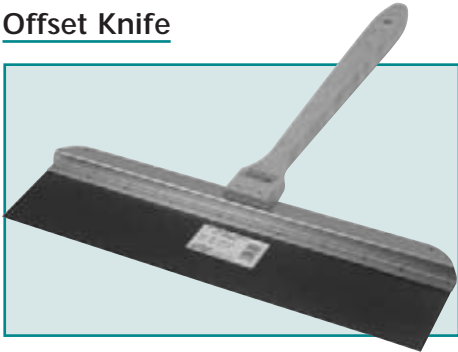
**Offset Knife**

CB14081 18" offset knife w/ 16" handle 6/ctn.

CB14082 24" offset knife w/ 16" handle 6/ctn.

Broad Knife

Blue spring steel blade with shims attached to a 14" tube handle.



CB14040 7" broad knife 6 /ctn.

CB14041 9" broad knife 6 /ctn.

CB14042 7" replacement blade with 2 shims

CB14043 9" replacement blade with 2 shims

Blue Steel Blade – wood handle

CB14051 8" tapping knife 6/ctn.

CB14052 10" tapping knife 6/ctn.

CB14053 12" tapping knife 6/ctn.

CB14054 14" tapping knife 6/ctn.

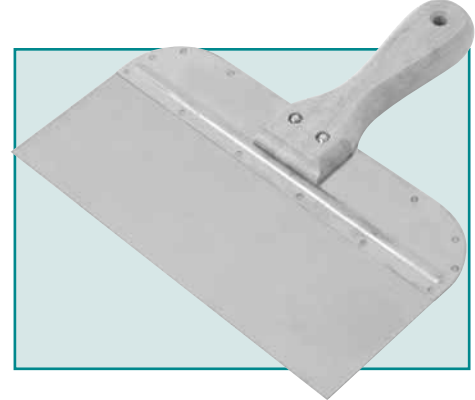
**Rubber Float**

Smooth moulded plastic handle with durable rubber base.



WT88007
4" x 9 1/2" rubber float 6/ctn.

Corner Pro Wipe Down Knife

Flexible rubber knife for finishing inside angles.



CB3077 12/ctn.

Mud Pans

Professional quality, double metal blade plastic pan.

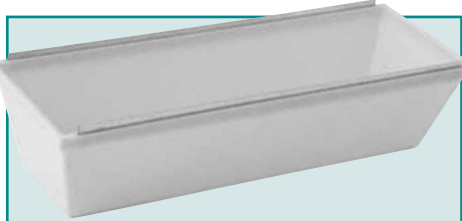

CB15005 12" plastic mud pan 12/ctn.

Heli-arc Mud Pan

Heavy Gauge, stainless steel with heli-arc welded corners and water tight construction.

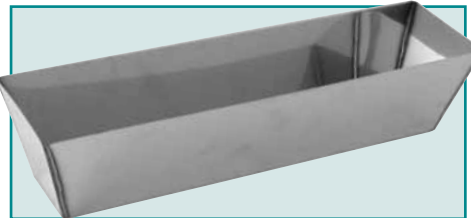

CB15007 12" heli-arc mud pan 12/ctn.

CB15008 14" heli-arc mud pan 12/ctn.

Stainless Steel Blade – wood handle

CB14061 8" tapping knife 6/ctn.

CB14062 10" tapping knife 6/ctn.

CB14063 12" tapping knife 6/ctn.

CB14064 14" tapping knife 6/ctn.

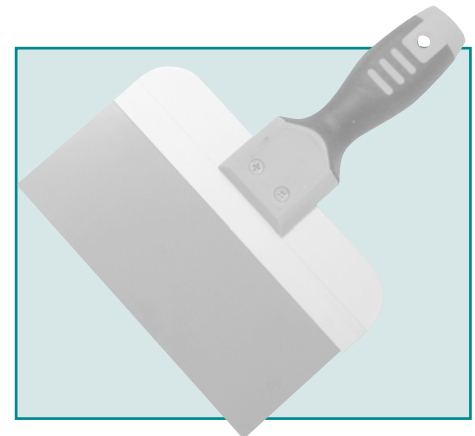
**Stainless Steel Blade – Rubber Grip**

CB14071 8" tapping knife 6/ctn.

CB14072 10" tapping knife 6/ctn.

CB14073 12" tapping knife 6/ctn.

CB14074 14" tapping knife 6/ctn.

Hand Mixers

All steel construction bonded to a wooden handle.

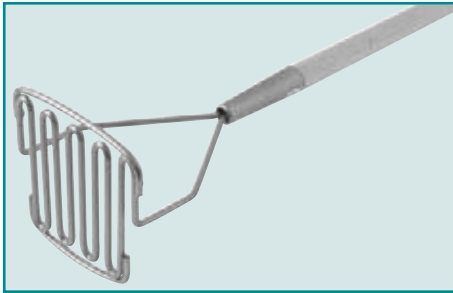

- WT42001** 25" square head mixer
- WT42002** 37" semi round head
- WT42004** 37" square head mixer

Circle Brand Mixing Paddles

Aluminum mixers for drywall compound, ceiling, wall texture and paint.

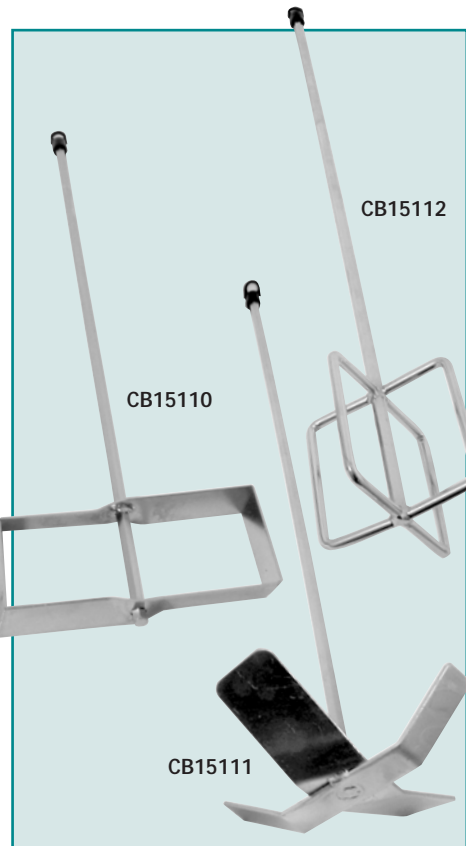

- CB15110 quick mixer**
29" shaft, 4" x 8" blade
- CB15111 flat blade mixer**
30" shaft, one blade
1 3/4" wide x 8" long, second
blade 1" wide x 8" long
- CB15112 square blade mixer**
28" shaft, 5" x 5" blade

Drywall Sanders



- CB15013** hand sander – plastic with metal clamp 10/ctn.
- CB15021** pole sander – plastic 9" x 3 1/4" (not shown) 10/ctn.

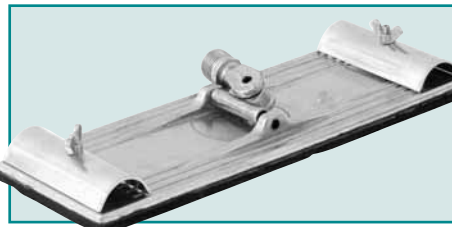

- CB15025** pole sander – metal with male end 10 /ctn.

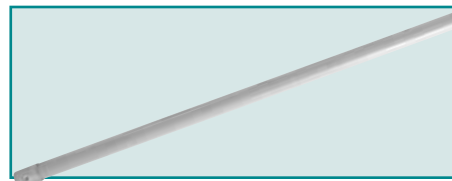

- CB15026** wooden sander pole with female metal end

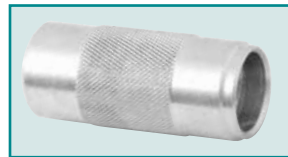

- CB15027** metal adapter for pole sander

Aluminum Extension Pole

Extendable from 4' to 8'.

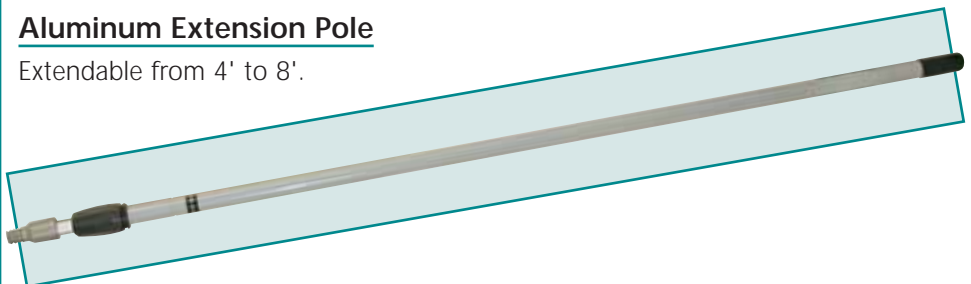

- CB15059** Aluminum extension pole

Universal Banjo

Stainless steel construction with thumb screw for mud adjustment. Complete with 2 wooden handles. Holds 500' roll of drywall tape.

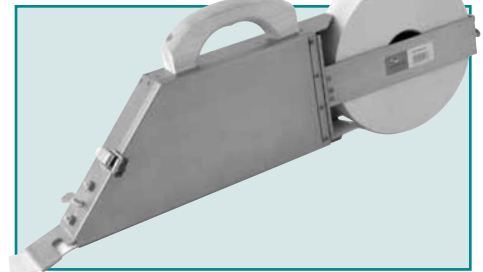

- ST0010** universal stainless steel banjo, for either left or right hand use.

Tape Reel

All steel construction. Holds 500' of tape with handy belt clip.

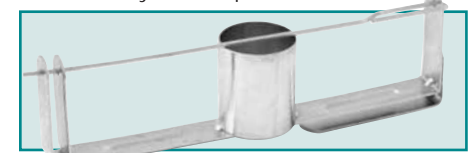

- CB15010** drywall tape reel 12 /Box

Inside Corner Roller



- ST0230** – Applies drywall compound to inside corners, embedding drywall tape

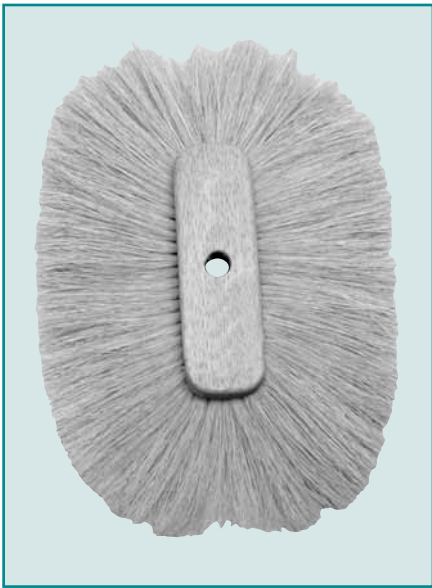

Single Texture Brush

WT62012 Single texture brush,
White Tampico, 8" x 1³/₄"

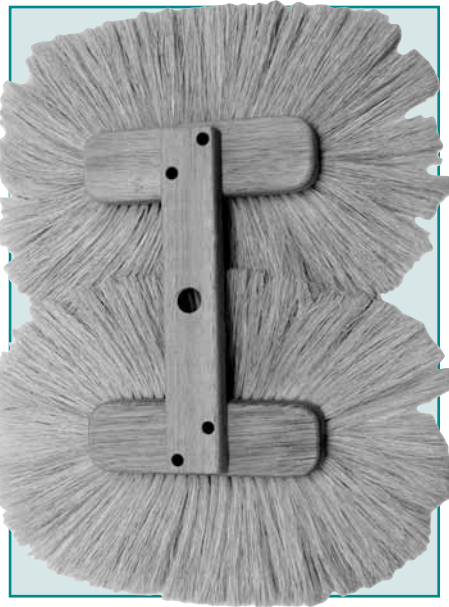
Double Texture Brush

WT62009 Double texture brush,
White Tampico, 8" x 1³/₄"

Round Texture and
Jumbo Texture Brush

WT62005 Round texture brush,
4³/₄" diameter
Horse hair

WT62011 Jumbo texture brush,
5³/₈" diameter
Horse hair

Floor Scraper

This scraper has a 5' steel handle welded to a heavy steel mounting bracket with plastic grip on end.

- | | | |
|---------------|---|---------|
| CB4008 | 7" x 4 ¹ / ₂ " floor scraper | 6 /ctn. |
| CB4010 | 14" x 4 ¹ / ₂ " floor scraper | 6 /ctn. |
| CB4012 | 20" x 4 ¹ / ₂ " floor scraper | 6 /ctn. |
| CB4009 | 7" replacement blade | |
| CB4011 | 14" replacement blade | |
| CB4013 | 20" replacement blade | |

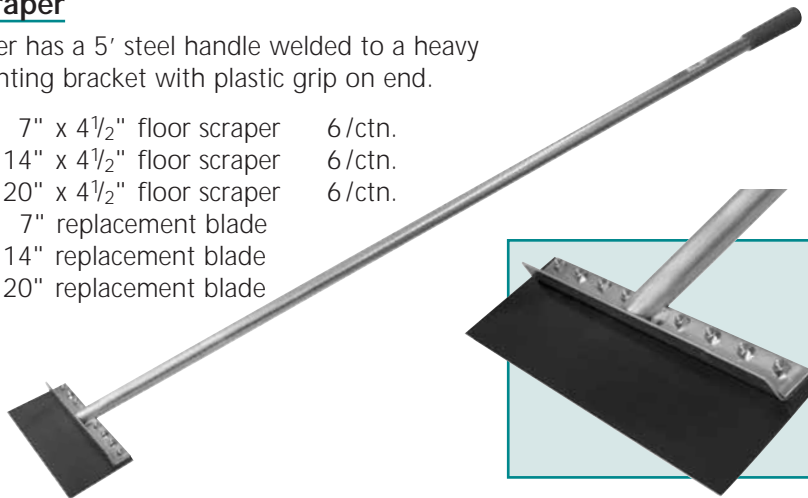
Wall Scraper

Spring steel blade bolted to aluminum angle mounting attached to 4' steel handle. Blade has right temper for perfect wall cleaning or scraping.

- | | | |
|---------------|-----------------------|---------|
| CB4014 | 18" wall scraper | 6 /ctn. |
| CB4016 | 24" wall scraper | 6 /ctn. |
| CB4015 | 18" replacement blade | |
| CB4017 | 24" replacement blade | |

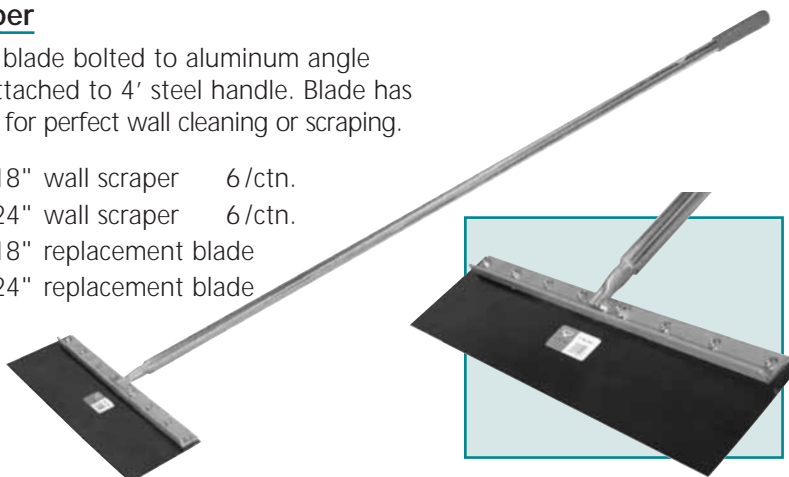
Access Panel

- Eliminates costly wall and ceiling repairs.
- Panel has perfect fit of lid and frame for maximum assurance against water and weather.
- Cosmetically desirable when panel must be located in sight.
- Made of long lasting A.B.S. with U.V. stabilizers and can be painted if desired.
- Can be installed on surface or flush mounted.



- | | | |
|---------------|-----------------|--------|
| AP69 | 6" x 9" panel | 6 /ctn |
| AP88 | 8" x 8" panel | 6 /ctn |
| AP1414 | 14" x 14" panel | 6 /ctn |
| AP1429 | 14" x 29" panel | 6 /ctn |

Spray Pro Gun and Hopper

- Flexible connector makes spraying difficult angles easy.
- Designed with faster recoil for greater spray control.
- Soft grip handle and trigger.

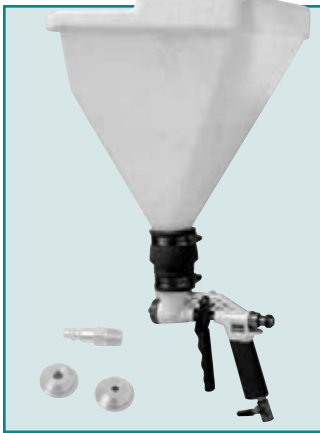

- WT56020** Spray Pro gun and hopper
- WT50004** Spray Pro hopper with clamp
- WT56023** Spray Pro gun

Wal-Pro Gun and Hopper

- One-piece body with brass components.
- Air shut-off valve and quick disconnect.
- Large capacity hopper with built-in angle.



- WT52005** Wal-Pro gun and hopper
- WT50007** Wal-Pro hopper with clamp
- WT52011** Wal-Pro gun

Spraying Mantis

Comes with hopper, gun and stand.



- WT55050** Spraying mantis with hopper, gun and stand
- WT55090** Spraying Mantis hopper
- WT55093** Spraying Mantis gun

Texture Spray Machine

Rotary vane compressor produces 6 CFM at 25 PSI 1 H.P. capacitor electric start motor with 25' electrical cord, and 50' of air hose. All steel construction cart with rubber wheels. Repair parts available.

- WT83005** Porta - compressor with Wal-Pro gun and hopper.
- WT83009** Porta - compressor with Spray Pro gun and hopper.

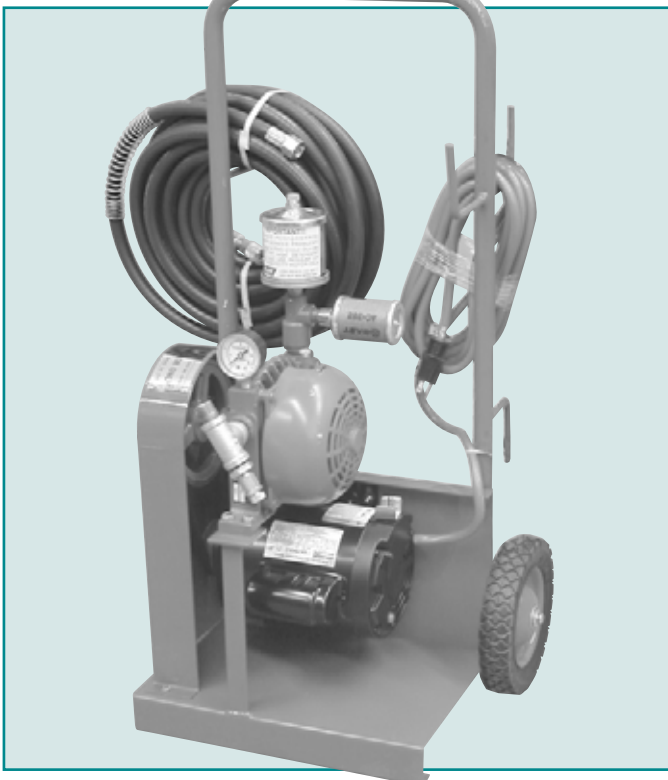

- WT50031** Hose 50'
- WT83022** Air filter for compressor
- WT83015** Pressure release valve

Glitter Gun

Manual applicator used to apply glitter.

Glitter – used for decorating walls and ceilings. Apply to fresh texture spray or wet paint. Uniform size will produce a consistent pattern or reflection.



- WT53019** Glitter gun – plastic
- WT53001** Silver glitter 1/16" square 1lb.
- WT53004** Diamond glitter 1/16" square 1lb.
- WT53007** Gold glitter 1/16" square 1lb.
- WT53017** Iris glitter 1/16" square 1lb.

Stucco Patch Gun

Used for patching small areas with stucco or plaster to match existing coating.



- WT54050** Stucco patch gun

North Dust Masks

7130 Dust/Mist Respirator
Ideal for sanding drywall and installing fiberglass insulation. NIOSH approved for respiratory protection against certain toxic dusts and mists.

7140 Dust/Mist Respirator
Same as 7130 but has exhalation valve for worker comfort in hot humid conditions.

S7130 dust / mist respirator
20 / box 12 box / ctn.

S7140 dust / mist respirator
10 / box 10 box / ctn.



Homax Texture Gun

Create your own custom look or match existing spray texture on walls or ceilings.



HO4505 Hopper 3L 6/ctn.
HO4205 DIY spray gun (gun only) 1/ctn.
HO4405 Pro spray gun (gun only) 1/ctn.

Dasheng Dust Masks

S2000 dust / mist respirator
20 / box,
20 box / ctn.*
**similar to Gerson
N95 masks*

S2010 Nuisance dust mask
50 / box,
20 box / ctn.



Pneumatic II Spray Texture Gun

Works with 3/4 hp or larger compressors, also HVLP compatible. Sprays 16 texture patterns including Super Fine Orange Peel.



HO4610 Pneumatic II Spray Texture Gun

Touch Up

Repair damaged textures on walls and ceilings with wall spray and acoustical touch up kits.

HO4105 Wall spray touch-up kit with pump

HO4105A Texture spray touch-up refill

HO4120 Acoustical touch-up kit with pump

HO4122 Refill twin pack for HO4120



Homax Spray Textures

To texture small areas (up to 100 sq. ft.) or to patch existing walls or ceilings that have already been sprayed.



HO4155 Wall texture 20 oz.*
HO4165 Knockdown texture 20 oz.*
HO4181 Acoustic ceiling texture 16 oz.*
*12/ctn.



CIRCLE BRAND DIECUT SANDPAPER



SP335	#100 grit 4 3/16" x 11 1/4" diecut sandpaper	100 / pk.
SP336	#120 grit 4 3/16" x 11 1/4" diecut sandpaper	100 / pk.
SP337	#150 grit 4 3/16" x 11 1/4" diecut sandpaper	100 / pk.
SP338	#180 grit 4 3/16" x 11 1/4" diecut sandpaper	100 / pk.

CIRCLE BRAND SPONGE BACK SANDPAPER ROLLS



SP225	#120 grit 4" x 10m. sponge back roll	5 / ctn.
SP226	#150 grit 4" x 10m. sponge back roll	5 / ctn.
SP227	#180 grit 4" x 10m. sponge back roll	5 / ctn.

CIRCLE BRAND DRYWALL SANDING SCREENS

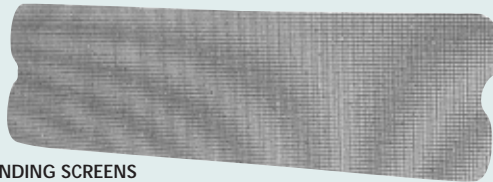

SANDING SCREENS

SPS100	#100 grit sanding screen	50 / pack
SPS120	#120 grit sanding screen	50 / pack
SPS150	#150 grit sanding screen	50 / pack
SPS180	#180 grit sanding screen	50 / pack

CIRCLE BRAND DRYWALL SANDPAPER ROLLS



SANDPAPER ROLLS

SP080	#80 grit 3 1/2" x 50 yds. roll	5 / ctn.
SP100	#100 grit 3 1/2" x 50 yds. roll	5 / ctn.
SP120	#120 grit 3 1/2" x 50 yds. roll	5 / ctn.
SP150	#150 grit 3 1/2" x 50 yds. roll	5 / ctn.
SP180	#180 grit 3 1/2" x 50 yds. roll	5 / ctn.
SP220	#220 grit 3 1/2" x 50 yds. roll	5 / ctn.

CIRCLE BRAND SANDING BLOCKS



DISPLAY BOX

ANGLED SANDING BLOCK

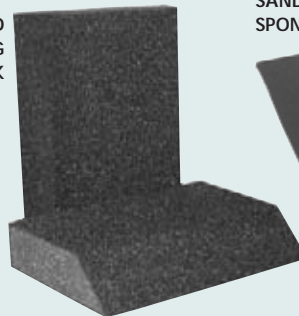

SANDING SPONGE

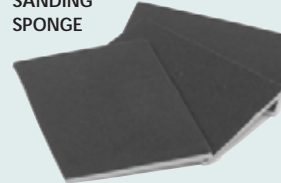

SANDING BLOCK



SPB01	medium / coarse sanding block display box	37 piece	SPB06	medium / fine angled block display box	24 piece
SPB02	medium / fine sanding block display box	37 piece	SPB07	medium / fine angled sanding block	each
SPB04	coarse sanding sponge 4.5" x 5.5"	50 / pack	SPB08	medium coarse sanding block	each
SPB05	medium sanding sponge 4.5" x 5.5"	50 / pack	SPB09	medium fine sanding block	each

CIRCLE BRAND FIBERGLASS MESH TAPE



USED FOR RE-INFORCING DRYWALL JOINTS, CRACKS AND OTHER DRYWALL DETAIL WORK.

Apply self-adhesive mesh tape directly to drywall joint and cover tape with a setting type drywall compound. Finish joint using regular drywall compound as per manufacturer's instructions.

T3001	2" x 500' mesh tape	12 /ctn.
T3002	2" x 300' mesh tape	12 /ctn.
T3003	12" x 150' mesh tape	9 /ctn.
T3004	4" x 150' mesh tape	27 /ctn.
T3005	6" x 150' mesh tape	18 /ctn.
T3006	34" x 150' detail mesh	9 /ctn.
T3007	2 1/2" x 500' mesh tape type P	10 /ctn.
T3008	2" x 150' detail mesh	27 /ctn.
T3009	2" x 65' detail mesh	24 /ctn.

2 in 1 Mesh Taper

Designed for ease of use in both corners and flats. Taper is designed to accommodate 300' x 2" mesh tape roll.

ST0011 Mesh Taper 1 /ctn.

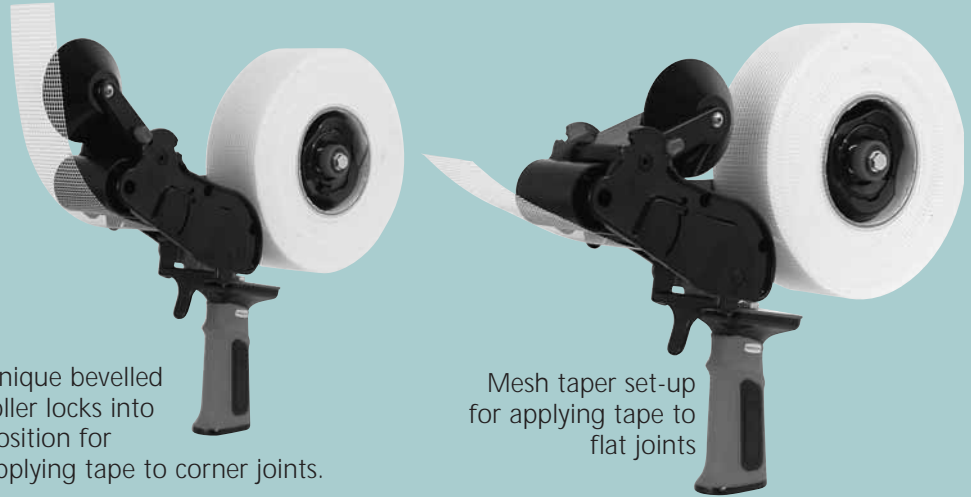

Unique bevelled roller locks into position for applying tape to corner joints.

Mesh taper set-up for applying tape to flat joints

CIRCLE BRAND



Wallboard Trim & Tool Inc is proud to offer
CIRCLE BRAND TOOLS
 Our own line of products designed for the
CONTRACTOR MARKET
 Well Made • Well Priced

Sure Corner Roll-on Bead

Two metal strips on paper designed for easy finishing of drywall corners and off angles. Apply with adhesive or drywall compound.

T3010 2" x 100' roll-on bead
 10 /ctn.



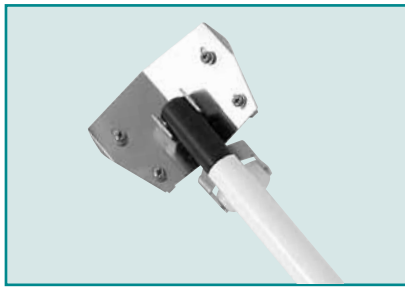

45° CORNER FLUSHER W/ HANDLE
BE005 45° 2" flusher with guide
BE006 45° 3" flusher
BE007 3" combo flusher

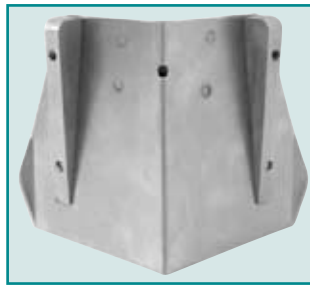

CORNER FLUSHER
BE020 2" corner flusher
BE021 3" corner flusher
BE022 3½" corner flusher
BE023 4" corner flusher

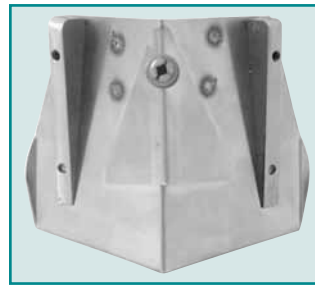

DIRECT FLUSHER
BE025 2" direct flusher
BE026 3" direct flusher
BE027 3½" direct flusher
BE028 4" direct flusher

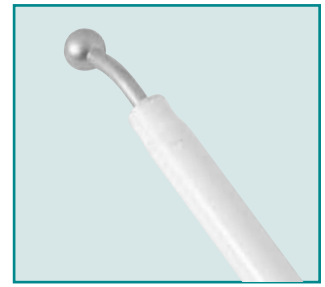

CORNER FLUSHER HANDLE
BE030 flusher handle
BE031 ball end
BE032 retainer spring

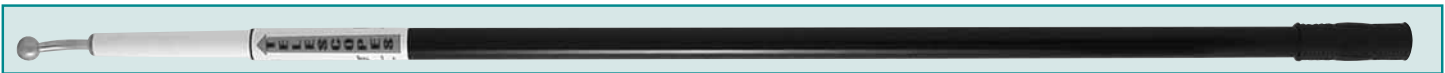

BE035 extension pole 2' to 3½'

FLUSHER EXTENSION HANDLES

BE036 extension pole 3' to 5½'

BE037 extension pole 4' to 7½'

Compound Applicators



BE010 45° inside angle corner applicator



BE011 45° outside corner applicator



BE012 inside corner applicator
BE015 wheel assembly kit



BE013 outside corner applicator



BE014 flat applicator

Super Sander Extension Pole

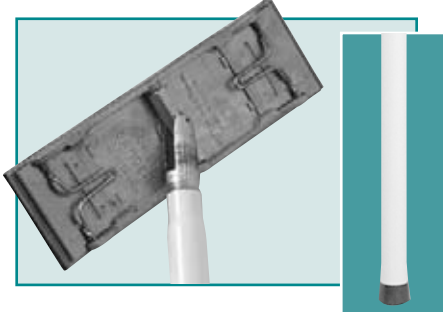

BE050 super sander w/ handle
BE051 super sander head only
BE052 super sander ext. pole 2' to 3½'
BE053 super sander ext. pole 3' to 5½'
BE054 super sander ext. pole 4' to 7½'

Inside Corner Roller



BE017 inside corner roller with 48" handle

Outside Angle Roller



BE016 outside angle roller with 48" handle

Super Taper



BE057 super taper
BE059 bucket & belt

Compound Tube

For corner flusher

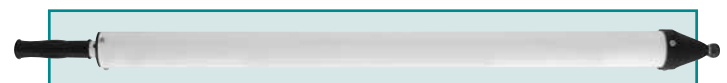

BE040 18" compound tube
BE041 36" compound tube
BE045 ball end **BE046** piston kit **BE047** cone end **BE048** handle grip

Drywall Foot Lifters

Enables one man to lift board up to 3" on wall. Heavy duty construction.



CB4001 mini-lifter 6/ctn.



CB4002 economy mini lifter 6/ctn.



CB4003 roll lifter 2/ctn.

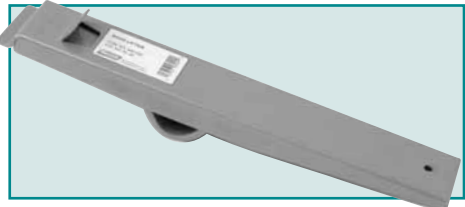

CB4004 fixed fulcrum lifter 2/ctn.

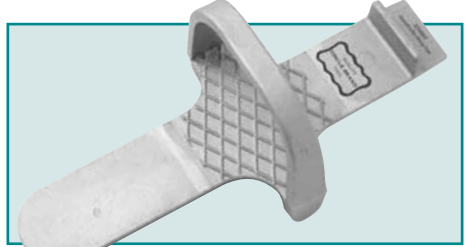

CB4005 stirrup lifter 2/ctn.

Rubber Tipped Line Clamps

The preferred clamp for installing T-Bar ceilings.



CB15032 4" line clamp 100/ctn.

Jet Line

CB15033
Jet Line 450'

**Drywall Circle Cutter**

Cuts up to 16" diameter. Hardened steel cutting blade for longer life.

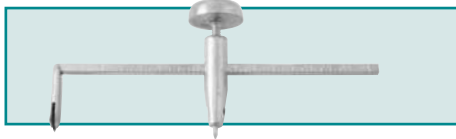

CB15250 circle cutter 12/ctn.

Drywall Stripper

Perforated wheels cut both sides of drywall. Ideal for narrow, hard to make cuts. Wood handle features an adjustable thumb screw to cut 4½" or less.

NEW

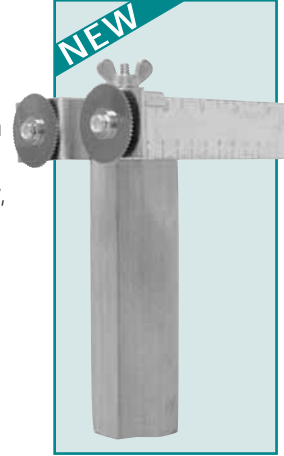

CB15028 Drywall Stripper
CB15028A Replacement Wheels (2)

Drywall Saws

Heavy duty 6" utility saw with steel blade and chisel point to penetrate drywall. Special tooth design for long life. Bonded wooden handle.



WT04001 6" utility saw 6/ctn.

Shark Drywall Saw

CB38048 6" shark saw w/ rubber grip 12/ctn.

Rockeater Drywall Saw

High quality carbon steel, tempered for long lasting sharpness. Chisel point blade with ergonomic elastomer handle.



ST0227 6" drywall saw 12/ctn.

Drywall Saw

Solid, high impact plastic handle. Tough, stiff blade with coarse teeth.



CB38040 15" drywall saw 6/ctn.

Utility Knives

Wallboard fixed blade utility knife with knurled handle.



WT15001 wallboard knife 12/ctn.

Shark utility knife – fixed blade. Comes with 3 blades.



CB38045 shark knife 6/ctn.

Utility Knife Blades

Replacement blades for utility knives.

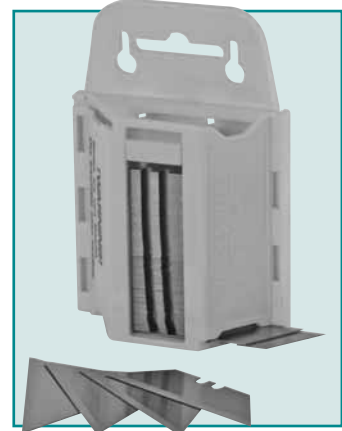

CB38043 Double notch type blades in a plastic case. 100/case

Mini Stud Crimper

Ideal tool for joining metal studs to metal track.

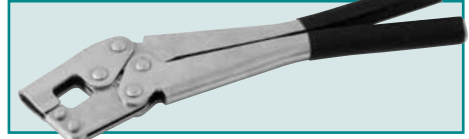

ST0001 mini stud crimper 1/ctn.

AVIATIONSNIPS

Midwest Aviation Snips

Cuts soft sheet metal up to 18 gauge. The compound lever action makes cutting easy.

- ST6716L left cut 6/ctn.
- ST6716S straight cut 6/ctn.
- ST6716R right cut 6/ctn.
- ST6716A long cut 6/ctn.

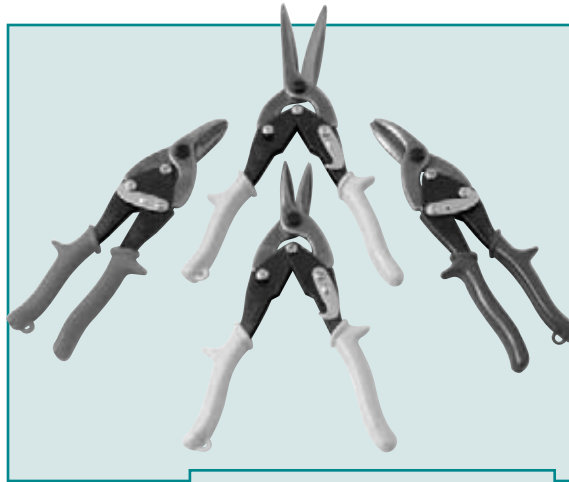

Midwest "Bulldog" Aviation Snips

ST6716B Cuts Heavy Gauge Framing Steel

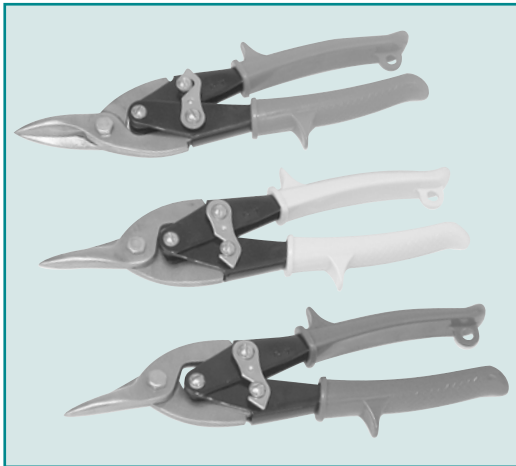

Circle Brand Aviation Snips

Cuts metal stud and track up to 18 gauge.

- CB4100 straight cut 6/ctn.
- CB4101 left cut 6/ctn.
- CB4102 right cut 6/ctn.

Circle Brand 25' Measuring Tapes



Experience the stability of our rigid 1" wide tape widths when measuring long distances and/or heights. Double locking mechanism (hold and release or lockup).

- CB38075 Imperial 6/ctn.
- CB38076 Imperial & Metric 6/ctn.

Chalk Line Reel

CB15031 100' heavy duty metal reel. 6/ctn.



8 oz. Chalk Line Refill



- ST0200 Red
- ST0201 Blue

T-Squares

Anodized aluminum finish. Heavy duty 3/16" blade.

- CB4000 54" with 3/16" blade*
 - CB3999 48" with 3/16" blade*
- *6/ctn.

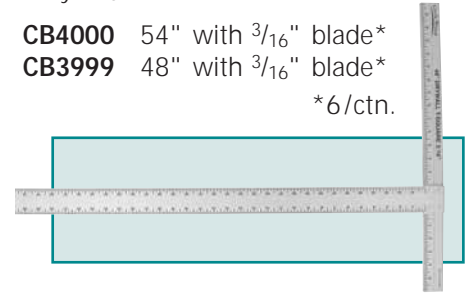

Nylon Mason's Line

Braided nylon mason's line. Gold only.

- ST0210 500' Gold 6/ctn.



Wallboard Rasp



- ST0221 drywall rasp 5 1/2"
- ST0222 replacement blade

Cornerbead Clincher Tool

For fastening metal cornerbead without using nails or screws.



- ST0002 1/4" clincher 1/ctn.
- ST0003 1/8" clincher 1/ctn.
- ST0004 clincher repair kit 1/bag
- ST0005 replacement striker head 1/ctn.

Rubber Mallet



- CB17523 16 oz. rubber mallet
- CB17524 24 oz. rubber mallet
- CB17525 32 oz. rubber mallet

Fiberglass Handles

- Innovative designing makes Premier International handles both durable and lightweight.



- PI-HR** Corner Roller Fiberglass Handle
- PI-HF** Corner Finisher Fiberglass Handle
- PI-HA** Corner Applicator Fiberglass Handle
- PI-HN** Nail Spotter Fiberglass Handle



EasyClean™ Box

- A Premier International innovation.
- Spring-assisted pressure plate reduces effort required to apply joint compound.
- Large joint compound capacity and easy clean feature.
- Comes in 7", 10" and 12" boxes.

- PI-22** 7" EasyClean™ box
- PI-27** 10" EasyClean™ box
- PI-32** 12" EasyClean™ box



EasyClean® Pump

- Anodized for added durability.
- Attachments allow filling of all Premier International tools.
- Coarse and fine filtering screens available.
- EasyClean™ feature.

- PI-72** EasyClean™ Pump



- PI-85** Gooseneck – stainless steel



- PI-90** Filler nozzle – stainless steel

Flat Boxes

- User adjustable blade holder fine tunes the crown for proper compound distribution.
- Comes in 7", 10" and 12" boxes.

- PI-20** 7" flat box
- PI-25** 10" flat box
- PI-30** 12" flat box



Power Assist™ Box

- A Premier International innovation.
- Spring-assisted pressure plate reduces effort required to apply joint compound.
- Large joint compound capacity and easy clean feature.
- Comes in 7", 10" and 12" boxes.

- PI-24** 7" Power Assist™ box
- PI-28** 10" Power Assist™ box
- PI-33** 12" Power Assist™ box



Corner Finisher

- Spring-loaded action compensates for imperfect angles.
- Premier International provides 3 versions of this convenient tool.
- 3" EasyRoll™ Adjustable, 2" and 3" standard.
- Fits PI-HA and PI-HF handles.

- PI-40** 2" Corner Finisher
- PI-45** 3" Corner Finisher
- PI-48** 3" EasyRoll™ Corner Finisher

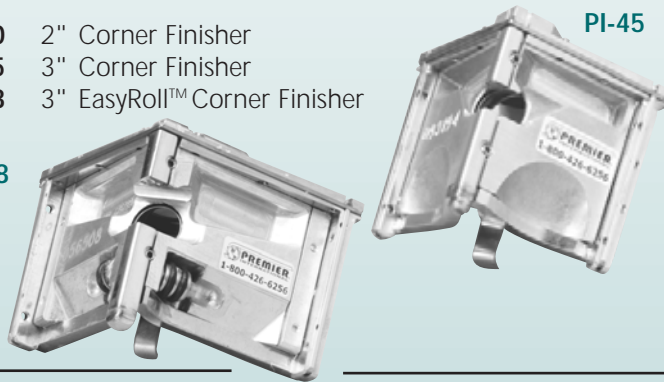

PI-48

Automatic Taper

- Built with stainless steel and aluminum components for light weight and durability.
- Reaches 3m height.
- Smoothest operating automatic taper available.
- Designed to be easily cleaned and maintained.



PI-04 Automatic Taper

EasyClean™ Nail Spotter with Handle

- Fills an entire row of dimples in one pass.
- Two tool sizes to work on any job – 2" and 3".
- Rugged stainless steel construction.
- Uses skid instead of wheels to extend blade life.
- Fits handle PI-HN.

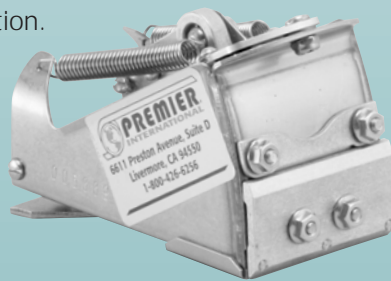

- PI63** 2" EasyClean™ Nail Spotter
- PI68** 3" EasyClean™ Nail Spotter

Box Xtender™ Handle

- Integrated brake provides precise control of box.
- Xtender™ Handle gives multiple lengths in one telescopic unit.
- One handle will fit all PowerAssist™ Boxes and Flat Boxes.
- Position can be extended to reach 3.5m without scaffold.

PI-88 Box Xtender™ Handle

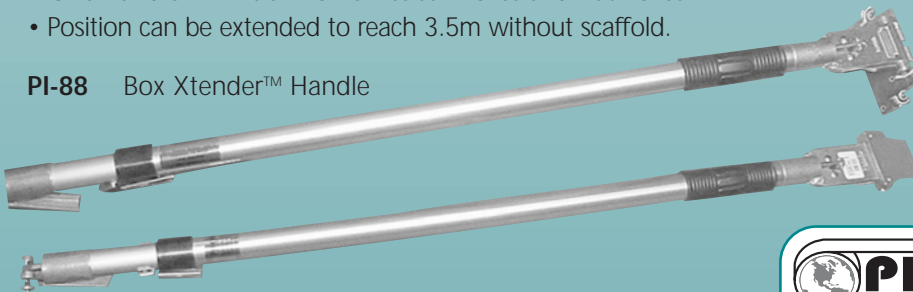

MudRunner™

- Ball joint allows flexible positioning.
- Twist-grip flow control.
- Attaches directly to Corner Finisher and Mud Heads.
- State-of-the-art applicator.
- Delivers compound to corner tools with low effort.

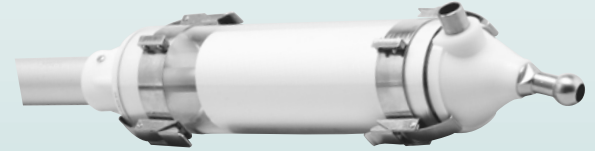

PI-14 MudRunner™

Corner Roller with Handle

- Lightweight and durable tool used to bed the tape.
- Forms a sharp corner at the same time.
- Reaches 3m height.
- Embeds paper or paper face beads on internal 90° angle.
- Fits handle PI-HR.



PI-15 corner roller with handle

Mud Head

- Applies a wide ribbon of joint compound to external corners.
- A quick and easy way to prep a corner for a paper faced corner bead.
- Attaches to the MudRunner and Corner Applicator.



PI-16 Mud Head

Corner Applicator

- Used with angle head to apply compound to 90° corner joints.
- Lightweight and strong, comes with fixed handle.

- PI-50** 7" corner applicator
- PI-35** 8" corner applicator



Shingling Hammers

Square Serrated driving head, blade is notched for nail removal and has an adjustable depth indicator.



- CB17534** 14 oz. Solid Hickory Handled Shingling Hammer 6/ctn.
- CB17535** 14 oz. Rubber Grip Steel Shank Shingling Hammer 6/ctn.

Drywall Hammers

Serrated driving head, and blade is notched for nail removal. Available with Rubber Grip or Solid Hickory Handles.



- CB17531** 14 oz. 13" Rubber Grip Drywall Hammer. Flat top for nailing in corners 6/ctn.
- CB17532** 14 oz. Hickory Handled Drywall Hammer 6/ctn.
- CB17533** 14 oz. Rubber Grip Drywall Hammer 6/ctn.

Vaughan Drywall Hatchets

Milled crowned face, thin blade 2 1/4" cut, beveled nail slot. Fully polished head with hickory handle. Vaughan WB patented flat head for nailing close to corners. Milled crowned face, thin blade. Sure-lock wedged.

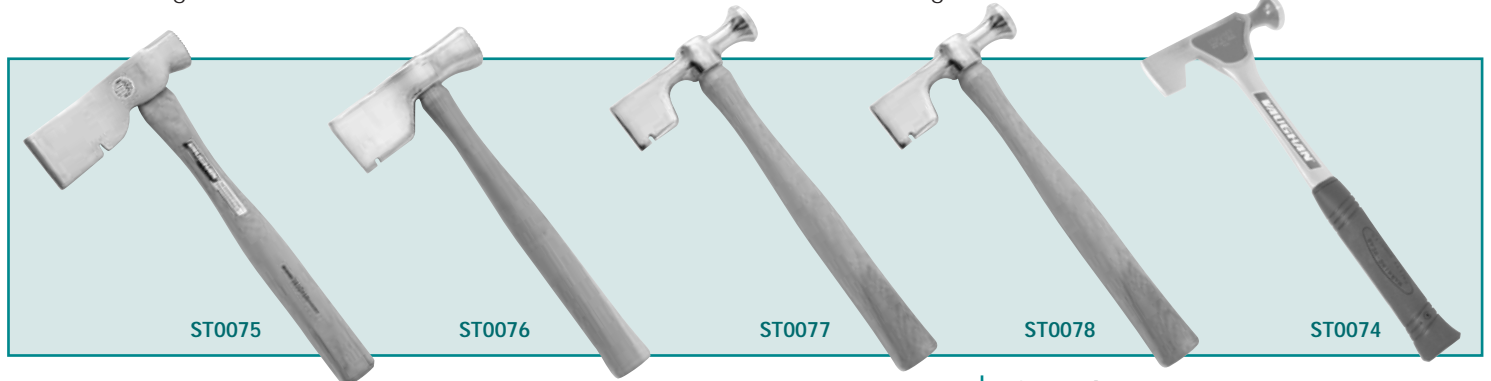

- ST0075** BX2 hatchet 2/ctn.
- ST0076** UDH hatchet 2/ctn.
- ST0077** WB hatchet 15 1/4" handle 2/ctn.
- ST0078** WBS hatchet 13 1/4" handle 2/ctn.
- ST0074** RWB Steel Hatchet 2/ctn.

Handles

- ST0080** 641-21 replacement 15 1/2" long handle with wedge
- ST0081** 641-31 replacement 13 1/2" short handle with wedge

Wal-Board Drywall Hammer

Forged, heat treated, steel head with convex, serrated face designed to set nail in a perfect dimple. Wooden handle.

- WT02001** WH-12 12 oz. head / 14" handle 6/ctn.
- WT02002** WH-12X 12 oz. head / 16" handle 6/ctn.
- WT02003** WH-17 16 oz. head / 14" handle 6/ctn.
- WT02008** WH-21 21 oz. head / 14" handle 6/ctn.

Hammer Handles

- WT02005** 14" replacement handle with wedge
- WT02006** 16" replacement handle with wedge



Superbar

Three beveled nail slots, polished sharp blades for easy insertion.

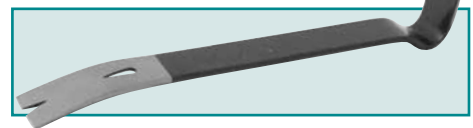

- ST0079** 13" bar 6/ctn.

Magnetic Nail Punch

Steel punch with magnetic end made for driving nails in hard to reach places.

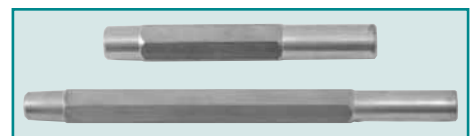

- ST0006** 5 1/2" punch 6/ctn.
- ST0007** 8" punch 6/ctn.

Drywall Tool Pouch

Top grain leather with rust resistant hammer, tape and snip holder.



CBL002 drywall tool pouch – left hand
CBL003 drywall tool pouch – right hand

Utility Drill Holster with Slot

Made from 8.5 oz. top grain leather. Will hold most screw guns or drills.



CBL004 drill holster w/ slot – left hand
CBL005 drill holster w/ slot – right hand

Back Support Work Belt

3 1/2" back support reduces lower back strain and lined with suede for comfort.



CBL007 large
CBL008 medium
CBL009 small

Leather Work Belt 2"x 48"

General purpose work belt for nail bags and tool pouches. Crafted from 8 oz. vegetable leather.



CBL010 48" leather belt, 2" wide

Nylon Suspenders

Designed for use with tool pouches, nail bags and construction aprons.



CBL011 nylon suspenders – black

Knee Pad Set

Designed to provide comfort and protection for your knees during flooring or tiling installation projects.



CBL013 top grain leather
CBL014 split leather

Drywall Nail Bag

Drywall nail bag with adjustable nylon belt. Three separate pockets for carrying various fasteners.



CBL020 drywall nail bag

Nail / Tool Bag

Multi-use drywall nail and tool pouches with convenient metal or leather side loop for hammer or hatchet.



CBL021 nail/tool bag
10 pocket leather loop
CBL022 nail/tool bag
10 pocket metal loop

Drywall Nail Pouch

Made from 5 oz. top grain leather and are fully bonded for longer wear. Pockets are riveted for additional strength.



3 Pocket 5 Pocket 4 Pocket
CBL023 3 pocket nail pouch
CBL024 4 pocket nail pouch
CBL025 5 pocket nail pouch

Carpenters Tool Pouch & Apron

The all in one portable work pouch provides you with a variety of holders and pockets for different hand tools, fasteners, etc., to make your job easier.



CBL026 carpenters tool pouch and apron

Leather Hammer Holder

This holder conveniently attaches to your regular belt or to a work pouch.



CBL027 leather hammer holder

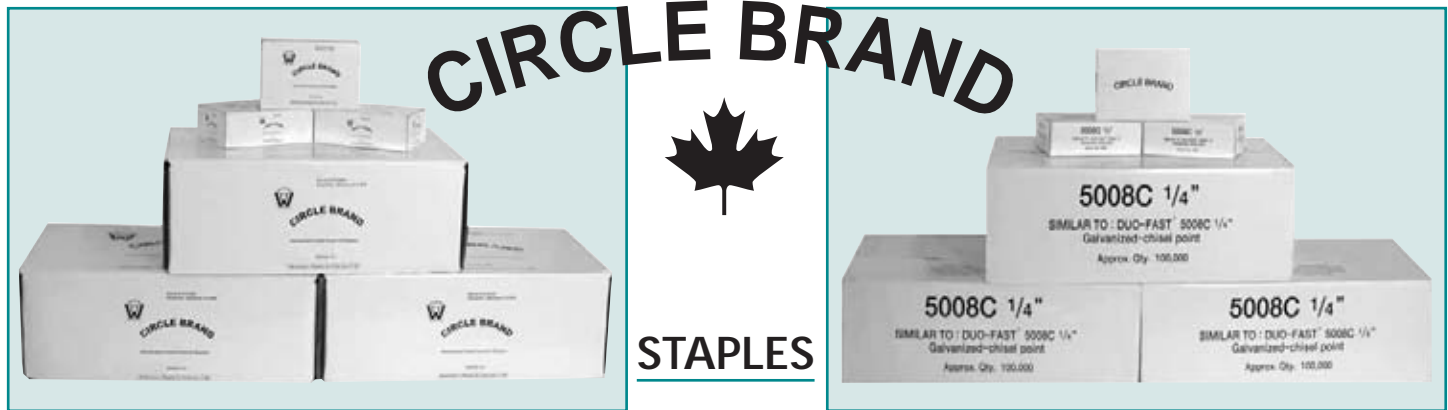

ST0582 1/4" staples - Similar to Spot Nail

- ST0582** 1/4" staples 5M/box*
- ST0583** 3/8" staples 5M/box*
- ST0584** 1/2" staples 5M/box*
- ST0581** 9/16" staples 5M/box*

*20 box/ctn.

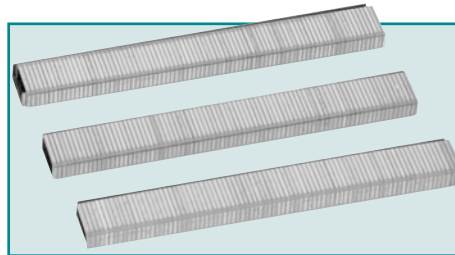

ST0585 1/4" staples - Similar to Duo-Fast

- ST0585** 1/4" staples 5M/box*
- ST0586** 3/8" staples 5M/box*
- ST0587** 1/2" staples 5M/box*
- ST0588** 5/16" staples 5M/box*
- ST0589** 9/16" staples 5M/box*

*20 box/ctn.

Staple Guns



ST0553 R11 Rapid hammer tacker takes up to 5/16" staples.

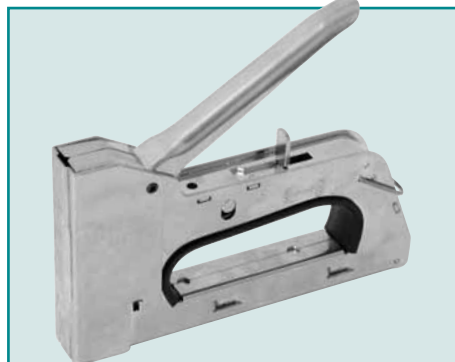

ST0554 R34 lever tacker takes up to 9/16" staples.

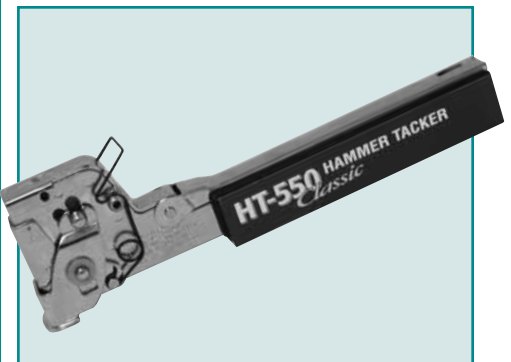

ST0550 Duo-Fast Hammer Tacker HT550

Prest-on®

DRYWALL FASTENERS



Sergeant Prest-on® introduces...



Corner-Back Clips

Prest-on Corner-back fasteners eliminate wood or steel stud backup at corners and ceilings. The result is faster framing and faster, easier drywall installation. Also great for Truss Uplift.



Insta-Back® Clips

Insta-back® makes removal and reattachment of any size piece of gypsum board quick and easy. Fasteners attach to existing board to provide a solid back-up surface for reattaching the replacement piece.



Framer Back Clips

Framer back drywall fastener eliminates the need for wood blocking at interior drywall corners and ceilings.

Corner-Back Clips

ST4001	1/2" D/W Corner-Back Clip	300/box	Bulk
ST4002	1/2" D/W Corner-Back Clip	500/box	Packaged 50 / Bag
ST4004	5/8" D/W Corner-Back Clip	300/box	Bulk

Insta-Back Clips®

ST4005	1/2" D/W Insta-Back Clip	200/box	Packaged 50 / Bag
ST4007	5/8" D/W Insta-Back Clip	200/box	Packaged 50 / Bag

Framer Back Clips

ST4010	D/W Framar Back Clip	300/box	Bulk
--------	----------------------	---------	------

Rotozip Tools

For cutting out electrical boxes, windows, etc. in drywall and other laminate materials.



ST0020 RZ1 Rotomite drywall cutter 1/ box

Bits for Rotomite



ST0026 SC5 saber cut 1/8" bit 5/ pack



ST0031 GP10 guidepoint zip 1/8" bit 10/ pack



ST0027 TC1 tile cut 1/8" bit 1/ pack



ST0032 - WD1 window and door 1/4" bit 1/ pack



ST0028 DC1 duracut 1/4" bit 1/ pack



ST0034 - FBR1 fiberrock 1/4" carbide bit 1/ pack



ST0030 ZB10 standard point 1/8" bit 10/ pack



ST0040 - XB-DW2 5/32" Drywall Bit - 2/ pack

These products are not shown

ST0029	CRCT1 circle cutter	1/ pack
ST0033	CH01 chuck adapter	1/ pack

ST0035	Collet 1/4"	1/ pack
ST0036	Collet 1/8"	1/ pack
ST0042	CT156 Collet 5/32"	1/ pack

ST0041	- XB-DW10 5/32" Drywall Bit	10/ pack
--------	-----------------------------	----------



Extendable Aluminum Plank

- ST0715 6' to 9' x 12" wide
- ST0716 7' to 11' x 12" wide
- ST0717 8' to 13' x 12" wide
- ST0718 10' to 16' x 12" wide

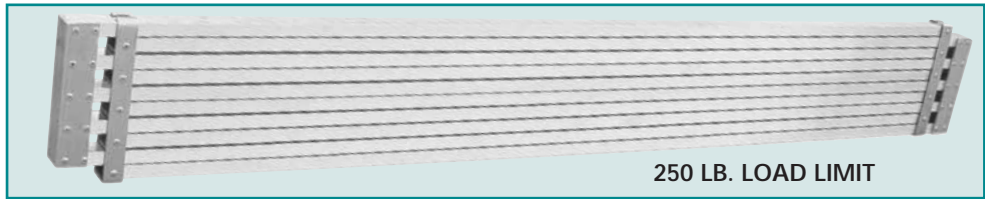

250 LB. LOAD LIMIT

Trojan Flat-Top Walkup Bench

- Heavy duty bolted hinge and spreader.
- 3" step.

9½" top step meets all OSHA requirements for under 4'.



300 LB. LOAD LIMIT

- ST0694 2' x 30" flat-top bench
- ST0695 2½' x 30" flat-top bench
- ST0696 3' x 30" flat-top bench
- ST0697 4' x 30" flat-top bench
- ST0719LHF Hinges for Flat-Top benches
- ST0719LS4 Spreader for 2' and 2.5' Flat-Top
- ST0719LS5 Spreader for 3' and 4' Flat-Top

Circle Brand Walkup Bench

- Adjustable from 18" to 30" working height.

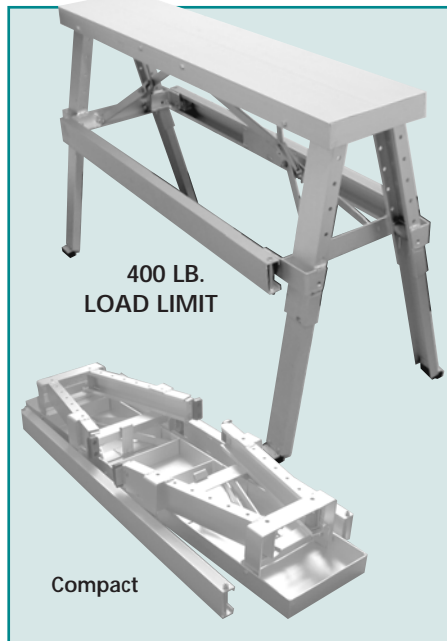

400 LB. LOAD LIMIT

Compact

Aluminum Benches

Heavy duty aluminum extrusion with non-slip ladder foot pads. Heavy duty spreaders for extra durability.

Top step is 7" wide.



300 LB. LOAD LIMIT

- ST0700 24" x 20"
- ST0701 30" x 20"
- ST0702 36" x 20"
- ST0703 48" x 20"
- ST0704 24" x 14"
- ST0705 36" x 14"
- ST0709 24" x 30"
- ST0710 30" x 30"
- ST0711 36" x 30"
- ST0712 48" x 30"
- ST0713 60" x 30"
- ST0714 72" x 30"
- ST0719LS1 Spreader (pair) 2' and 2½' bench
- ST0719LS2 Spreader (pair) 3' 4' and 5' bench
- ST0719LS3 Spreader (pair) 6' bench
- ST0719LH1 Hinges (pair) all regular benches

Multi-Way Ladders

- ST0740 multi-way ladder 7'
- ST0741 multi-way ladder 8'

Aluminum Step Ladders

- ST0735 double sided step ladder 6'
- ST0736 double sided step ladder 8'
- ST0737 double sided step ladder 7'
- ST0738 double sided step ladder 10'



Ladder Jacks

Jacks can be mounted on either the inside or outside of ladder. Double slot tooth arms add extra strength and stability.



ST0723 Ladder jacks– sold in pairs

Fiberglass Step Ladders – Grade 1

- Non-conductive fiberglass rails.
- Durable slip-resistant feet.
- Extra heavy-duty 3" serrated aluminum steps.

ST0742 6' fiberglass step ladder, yellow

ST0743 4' fiberglass step ladder, yellow

ST0744 8' fiberglass step ladder, yellow



**250 LB.
LOAD LIMIT**



ST0733
500 LB. LOAD LIMIT

ST0733A2

Mini-Mobile Utility Stand and Scaffolds

ST0733

- Mini Mobile Utility Stand with 4 casters, work station and tool tray.
- Unit Weight – 69.5 lbs. (31.5 kgs)
- Dimensions – 47" (120 cm) long x 22" (56 cm) wide x 48" (122 cm) high.
- Load Capacity – 500 lbs. (227 kgs.).
- Casters included.

ST0733A1

4" locking push-in type replacement caster for utility stand ST0733.

ST0733A2

Replacement Tray



Mini-Mobile Utility Stand and Scaffold Reference Chart

	ST0733 Mini-Mobile	ST0728 Aluminum Tower	ST0731 Aluminum Folding	ST0729 Steel Tower	ST0730 Steel Folding
Length	47" (120 cm)	74" (187 cm)	59" (150 cm)	74" (187 cm)	59" (150 cm)
Width	22" (56 cm)	29" (74 cm)	29" (74 cm)	29" (74 cm)	29" (74 cm)
Height	48" (122 cm)	72" (182 cm)	72" (183 cm)	72" (182 cm)	74" (189 cm)
Platform Type	2 Non-slip steel planks	28" wide aluminum platform	3 Non-slip alum. planks	28" wide plywood/ steel platform	3 Non-slip steel planks
Caster Type	4" Push-in	5" – Square Stem	5" – Round Stem	5" – Square Stem	5" – Round Stem
Unit Weight	69.5 lbs. (31.5 kgs)	85 lbs. (38.5 kgs)	66 lbs. (30 kgs)	143 lbs. (65 kgs)	132 lbs. (60 kgs)
Load Capacity	500 lbs. (227 kgs)	1000 lbs. (454 kgs)	800 lbs. (363 kgs)	1000 lbs. (454 kgs)	800 lbs. (363 kgs)
Colour	Yellow	Silver	Silver	Yellow	Yellow
Finish	Powder-Coated	Anodized	Anodized	Powder-Coated	Powder-Coated

6' Steel Folding Mobile Scaffold - ST0730

- Unit Weight – 132 lbs. (60 kgs)
- Dimensions – 59" (150 cm) L x 29" (74 cm) W x 74" (189 cm) H.
- Load Capacity – 800 lbs (363 kgs).
- Casters included

6' Aluminum Folding Mobile Scaffold - ST0731

- Unit Weight – 66 lbs. (30 kgs)
- Dimensions – 59" (150 cm) L x 29" (74 cm) W x 72" (183 cm) H.
- Load Capacity – 800 lbs. (363 kgs).
- Casters included.

Steel Plank

- For 6' Steel Folding Mobile Scaffold.
- 8.5" wide.

ST0730A1**Aluminum Plank - ST0731A1**

- For 6' Aluminum Folding Mobile Scaffold.
- 8.5" wide.

**5" Caster - ST0730A2/
ST0731A2**

- For 6' Folding Scaffolds Aluminium and Steel.
- Round stem.

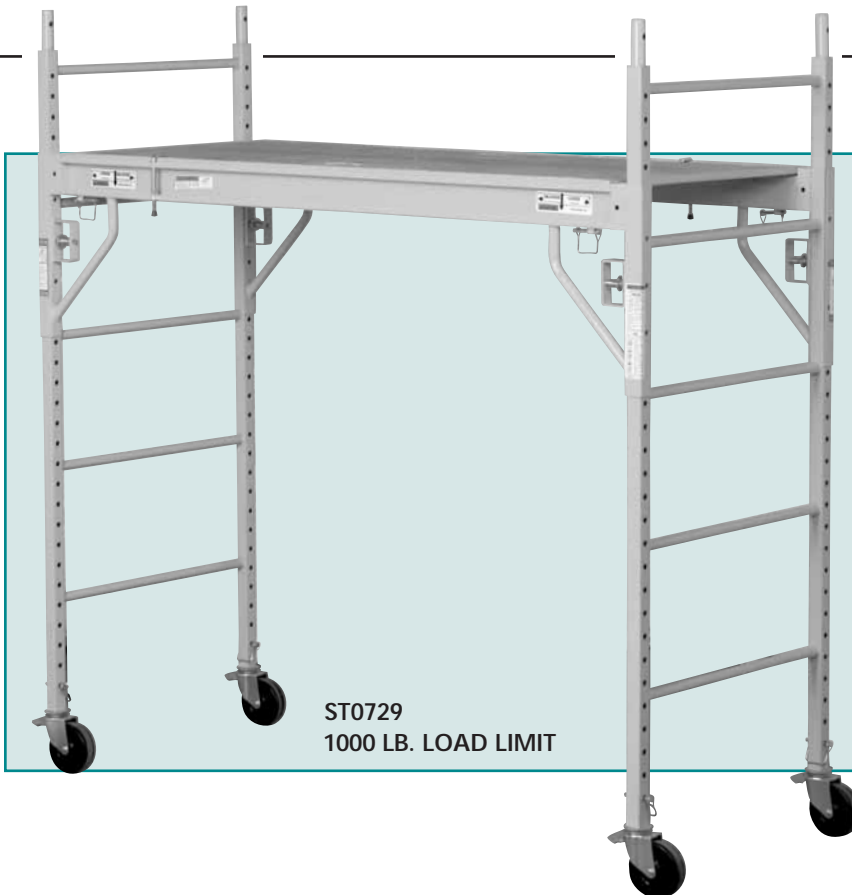
**6' Steel Rolling Tower Scaffold - ST0729**

- Unit Weight – 143 lbs. (65 kgs)
- Dimensions – 74" (187 cm) L x 29" (74 cm) W x 72" (182 cm) H.
- Load Capacity – 1,000 lbs. (454 kgs).
- Casters included.

5" Caster

- For 6' Rolling Tower Scaffold.
- Square stem.

ST0727

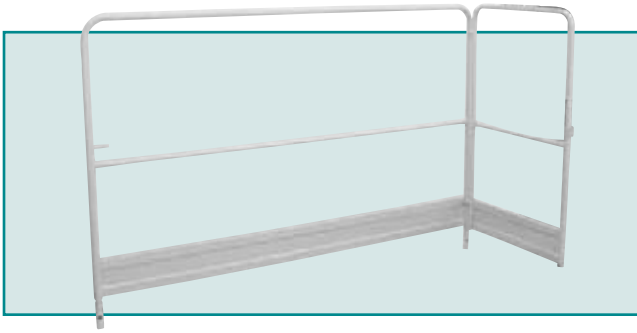

◀ **Steel Guardrail**

- For 6' Steel Tower.
ST0729A1

Steel Outriggers ▶

- With 5" caster.
- For 6' Steel Tower.

- ST0729A2** Large
- ST0729A3** Small.

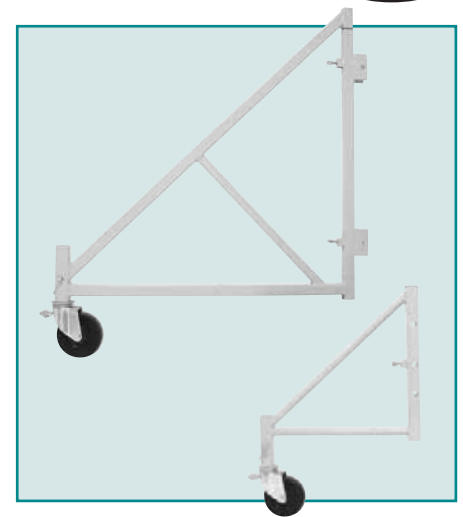

◀ **Plywood Platform**

- For 6' Steel Tower.
- 29" x 67".

ST0729A4

6' Aluminum Rolling Tower Scaffold - ST0728

- Unit Weight – 85 lbs. (38.5 kgs)
- Dimensions – 74" (187 cm) L x 29" (74 cm) W x 72" (182 cm) H.
- Load Capacity – 1,000 lbs. (454 kgs).
- Casters included.

5" Caster - ST0727

- For 6' Rolling Tower Scaffolds
- Square stem.

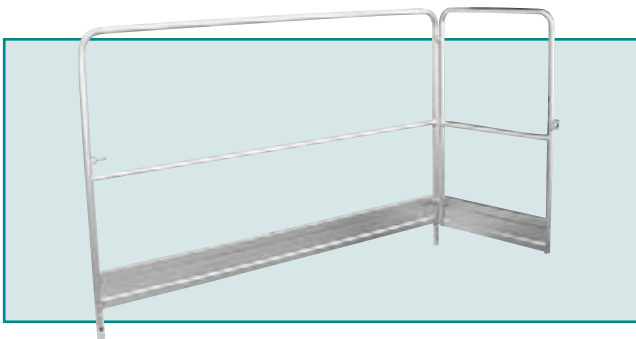
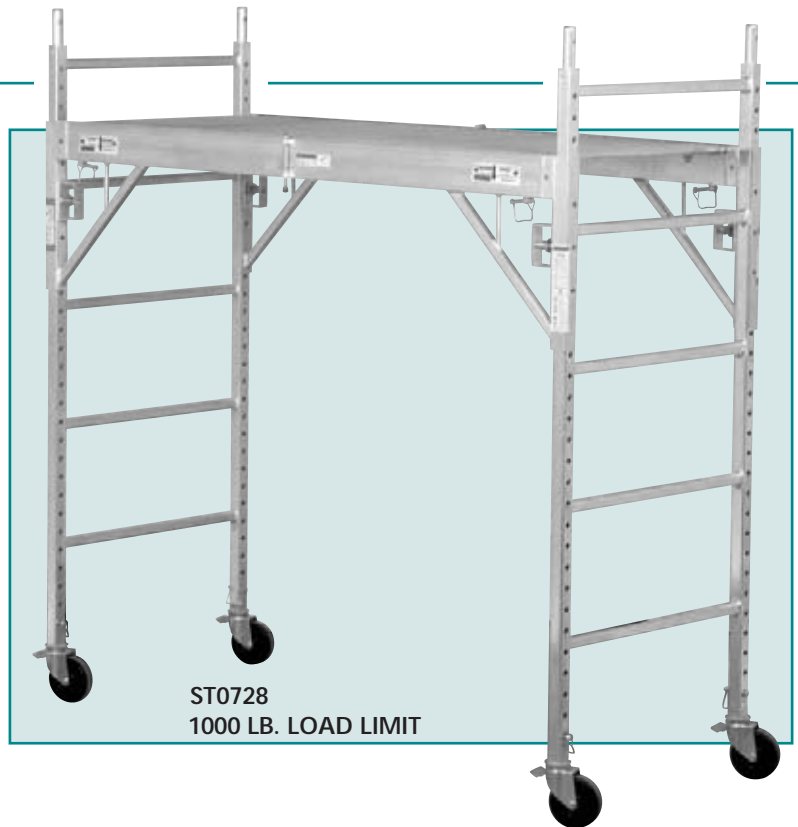

◀ **Aluminum Guardrail**

- For 6' Aluminum Tower.
ST0728A1

Aluminum Outriggers ▶

- With 5" caster.
- For 6' Aluminum Tower.

- ST0728A2** Large
- ST0728A3** Small

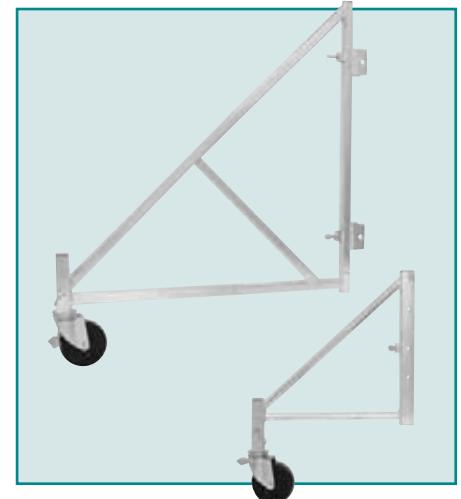

◀ **Aluminum Platform**

- For 6' Aluminum Tower.
- 29" x 67".

ST0728A4

Drywall Dollies – Ideal for handling drywall, plywood, panelling, etc. on the jobsite or in the warehouse. Dolly ST0101 is designed for loading drywall in confined spaces. Fixed dollies are a one piece welded unit. Modular dollies are shipped

disassembled with hardware included for easy assembly. Some models have a teflon plate over the steel base. *All dollies priced with wheels extra.* *When ordering, state type of wheels required, from selection shown below.*



Base Replacement

ST0107 – 10" wide Teflon base replacement.

	Type	Teflon Plate	Base Plate Width	Sheets of 1/2" Drywall	Overall Dimensions w/Wheels L x W x H
ST0101	Fixed	Yes	10"	20	46 (117) 19 (48) 41 (104)
ST0102	Fixed	Yes	12"	24	46 (117) 23 (58) 46 (117)
ST0103	Fixed	Yes	14"	28	46 (117) 24 (61) 47 (119)
ST0104	Modular	Yes	12"	24	47 (119) 23 (58) 44 (112)
ST0105	Modular	No	14"	28	47 (119) 25 (64) 44 (112)
ST0106	Fixed	No	16"	32	47 (119) 25 (64) 47 (119)

Wheel Selection

- Moulded Rubber – Standard Duty, Economical
- Donut Type – Heavy Duty. More resistant to picking up nails and screws



Moulded rubber dolly wheel. Black rubber, 8" x 2" swivel.

Moulded rubber dolly wheel. Black rubber, 8" x 2" fixed.

Donut type dolly wheel. Grey rubber, 8" x 2" swivel.

Donut type dolly wheel. Grey rubber, 8" x 2" fixed.

Donut type dolly wheel. Grey rubber, 8" x 2" swivel with locking device.

ST0110

ST0111

ST0108

ST0109

ST0109A



Foot straps at the toe and ankle help to balance your body weight and keep you tied into the stilts.



The durable nylon safety straps hold legs in place and gives you increased stability.

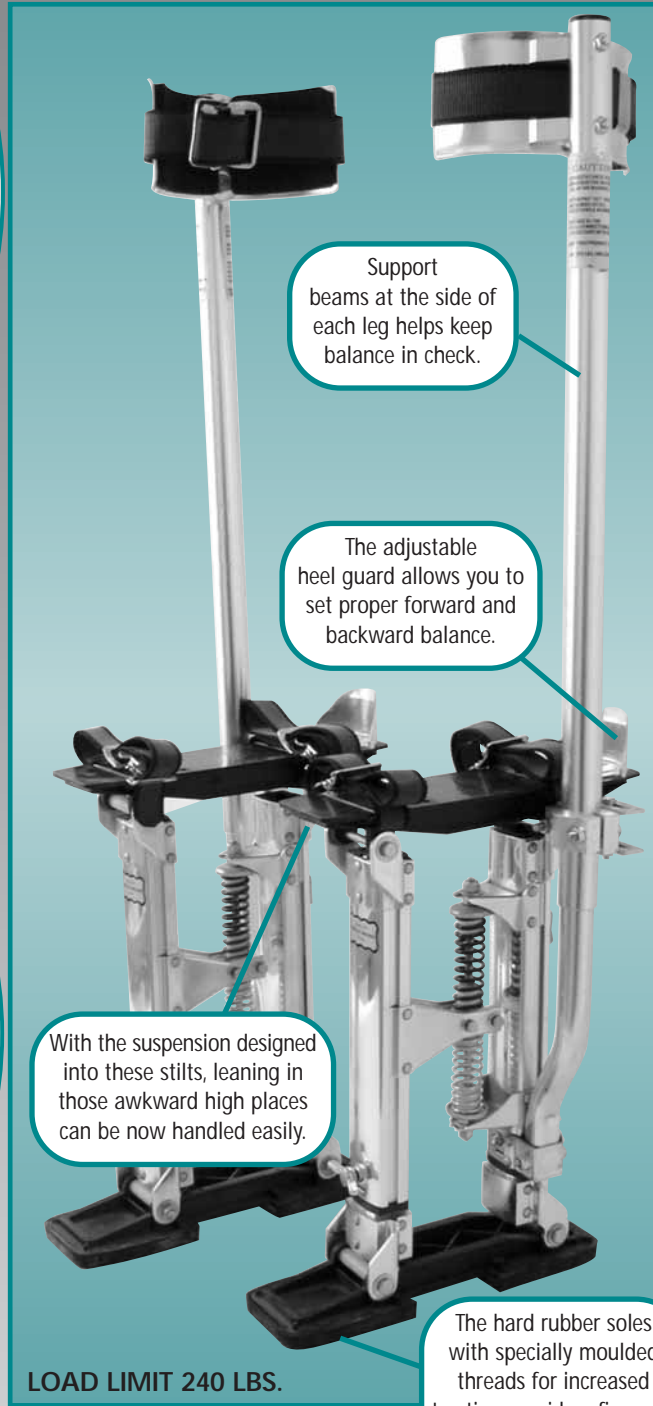

CIRCLE BRAND HEAVY DUTY ADJUSTABLE STILTS

Heavy duty side poles with rubber foot pads.
Replacement parts are available.



Aluminum

CBS005	Single Pole	15" to 23" stilts	1 / ctn.
CBS006	Single Pole	18" to 30" stilts	1 / ctn.
CBS007	Single Pole	24" to 40" stilts	1 / ctn.
CBS008	Single Pole	48" to 64" stilts	1 / ctn.

Magnesium

CBS010	Single Pole	18" to 30" stilts	1 / ctn.
CBS011	Single Pole	24" to 40" stilts	1 / ctn.
CBS013	Double Pole	18" to 30" stilts	1 / ctn.
CBS014	Double Pole	24" to 40" stilts	1 / ctn.

DL100-DRYWALL PANEL LIFTER

Drywall Panel Lifter

- Holds 4' x 12' sheets of drywall.
- Large 4" casters with side locks.
- 200 lb. capacity.

DL100 (SHOWN)

- 5' to 10' lifting height.
- Designed with quick locks for the legs.
- Heavy duty lifting cable.
- Base is designed for easy set up.

ST0750 DL100 panel lifter

DL125 (NOT SHOWN)

- 5' to 12¹/₂' lifting height.
- Heavy duty lifting cables.
- 30" outriggers – collapse to 8" radius for storage.
- Casters stay in contact with ground, even when collapsed, so lift is easy to maneuver at all times.
- 60" tall (without head)
38" loading height.
- Automatic brake.

ST0751 DL125 panel lifter

ST0752 Closet extension support arms for DL125

DL150 (NOT SHOWN)

- 6¹/₂' to 15' lifting height.
- 68" tall (without head).
- 47¹/₂" loading height.
- Heavy duty dual lifting cables for additional cable life
- 30" outriggers – collapse to 8" radius for storage.
- Automatic brake.
- Casters stay in contact with ground, even when outriggers are collapsed, so lift is easy to maneuver at all times.

ST0753 DL150 panel lifter

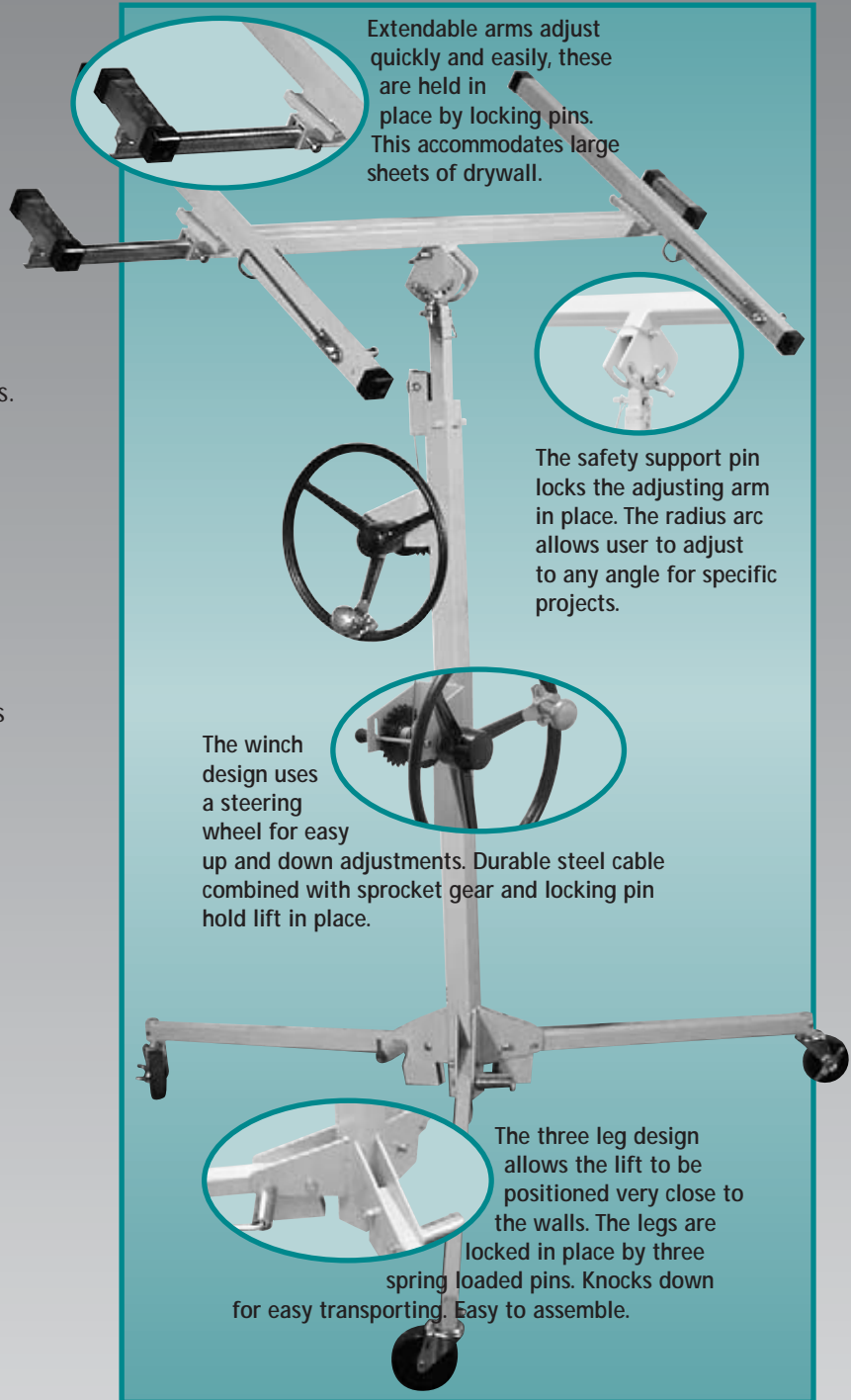

Extendable arms adjust quickly and easily, these are held in place by locking pins. This accommodates large sheets of drywall.

The safety support pin locks the adjusting arm in place. The radius arc allows user to adjust to any angle for specific projects.

The winch design uses a steering wheel for easy up and down adjustments. Durable steel cable combined with sprocket gear and locking pin hold lift in place.

The three leg design allows the lift to be positioned very close to the walls. The legs are locked in place by three spring loaded pins. Knocks down for easy transporting. Easy to assemble.

Drywall lift head features:

- Rigid design for secure placement of drywall board.
- Quick adjusting arms accommodate 8' to 12' drywall board.
- Tilting 360° rotating head to service cathedral ceilings and give greater flexibility.

*Wallboard Trim & Tool Inc. your
Canadian Distributor for*



TRIM-TEX INC.
VINYL DRYWALL TRIMS

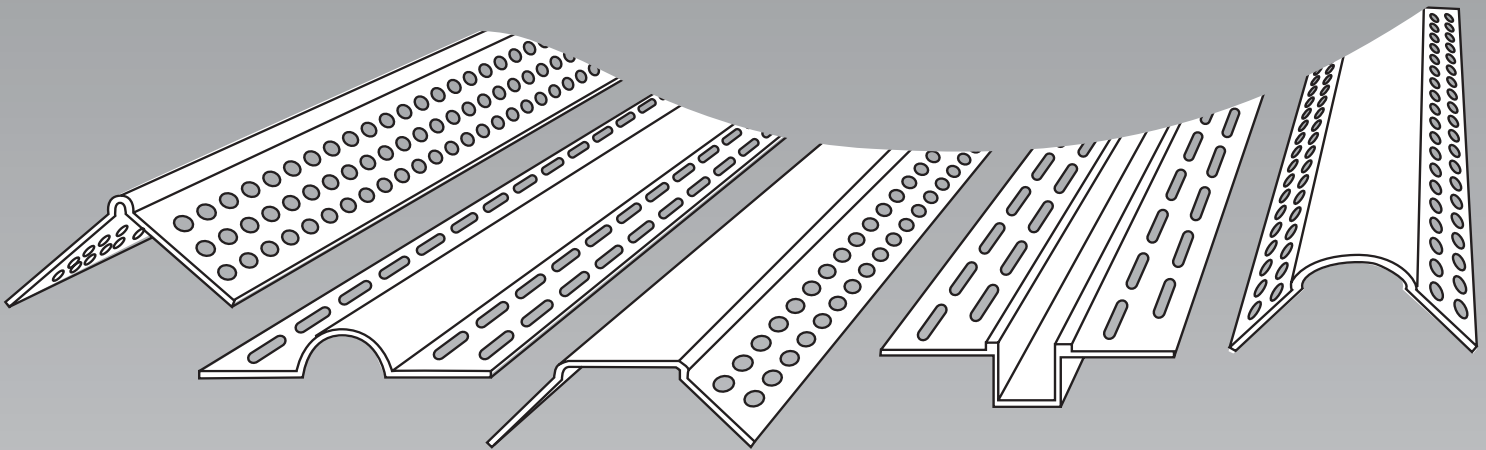

DRYWALL ART™

*Contact us for a full colour
Trim-Tex catalogue and pricing*



WALLBOARD Trim & Tool Inc.

All products listed in our catalogue are of the finest tradesmen quality. We are continually adding and updating our lines with top quality products. If you should require a tool or accessory not listed, it is possible we may have it in stock or we could try to source it for you.

**ALL ORDERS PLACED BY 11 AM EST
WILL BE SHIPPED SAME DAY**

For Sales and Customer Service

Telephone 905-669-6336
Toll Free Telephone 1-800-590-5799
Website www.wallboardtrim.com

Fax 905-669-9092
Toll Free Fax 1-800-833-5487
Email info@wallboardtrim.com



All merchandise will carry the manufacturer's guarantee.*

*In no event will Wallboard Trim & Tool Inc. be responsible beyond the cost of the item purchased.

Distributed By

